

INSTALLATION

➤ Instructions

Adapter Carthago Malibu

308078, 308079, 301417, 301418

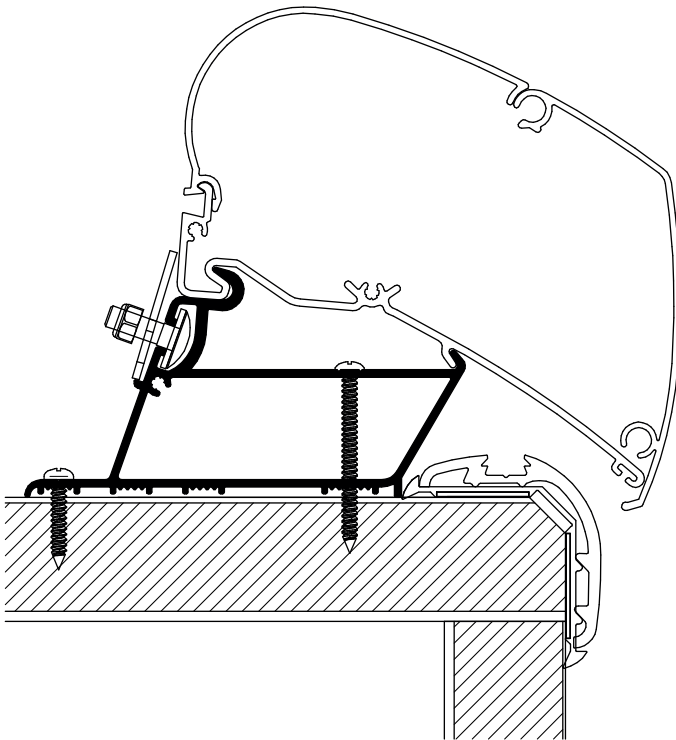

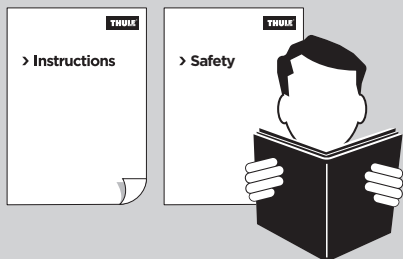

DE	Adapter - Bedienungsanleitung
NL	Adapter - Gebruikershandleiding
FR	Adaptateur - Instructions d'utilisation
IT	Adattatore - Manuale utente
ES	Adaptador - Manual de usuario
SV	Adapter - Användarmanual
FI	Adapteri - Käyttöohje
DA	Adapter - Brugermanual
NO	Adapter - Brukerhåndbok
PL	Adapter - Instrukcja obsługi

1	WARNINGS & INFO	4
	Warnungen & Info / waarschuwingen & info / avertissements et informations / avvertimenti e informazioni / advertencias e información / varningar & info / varoitukset ja tiedot / advarsler og info / advarsler og info / ostrzeżenia i informacje	
2	CONTENT	5
	Inhalt / inhoud / contenu / contenuto / contenido / innehåll / sisältö / indhold / innhold / zawartosc	
3	TOOLS	5
	Werkzeuge / gereedschappen / outils / strumenti / herramientas / verktyg / työkalut / værktøjer / verktøy / narzędzia	
4	FITGUIDE	5
	Anwendungstabelle / fitting tabel / table d'application / guida di adattamento / guía de aplicación / applikationstabell / sovellus taulukko / applikationstabel / applikasjonstabell / tabela aplikacji	
5	INSTALLATION	6
	Installation / installatie / installation / installazione / instalación / installation / asennus / installation / installasjon / instalacja	

1 WARNINGS & INFO

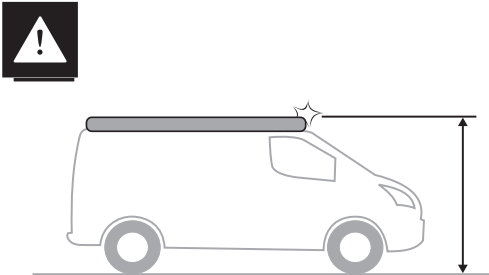
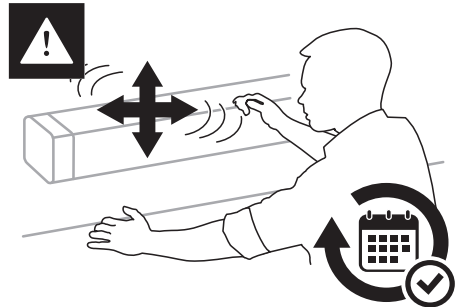
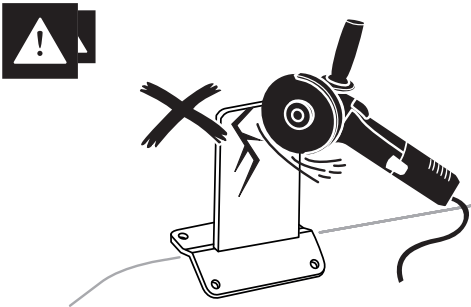
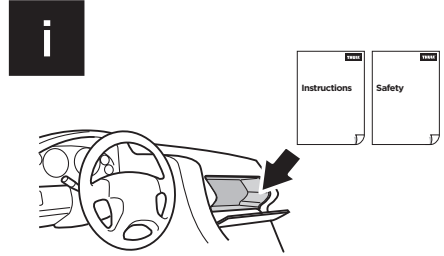
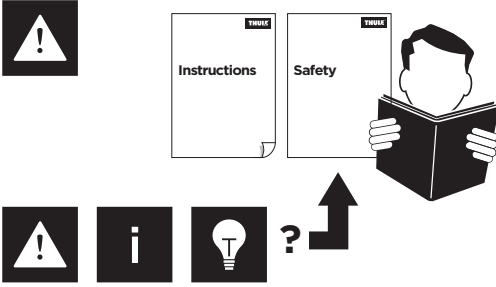

2 CONTENT

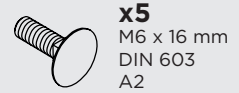
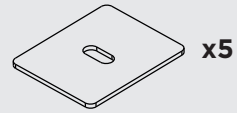
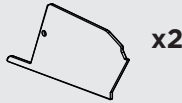
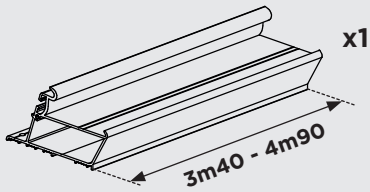

3 TOOLS

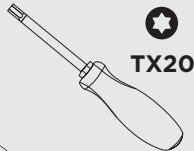
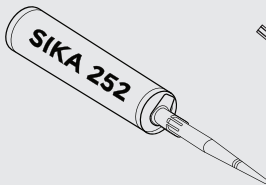

4 FITGUIDE

BRAND	MODEL	ADAPTER	AWNING
CARTHAGO	MALIBU	308078	TO 6300 - 3.50 m
CARTHAGO	MALIBU	308079	TO 6300 - 4.00 m
CARTHAGO	MALIBU	301417	TO 6300 - 4.50 m
FENDT	DIAMANT		
CARTHAGO	MALIBU	301418	TO 6300 - 5.00 m

5 INSTALLATION

1

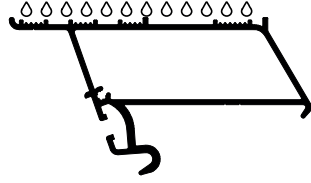
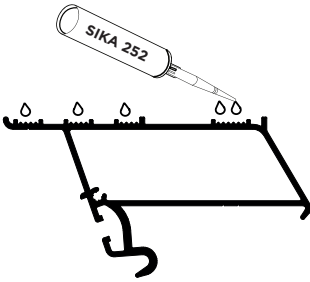

2

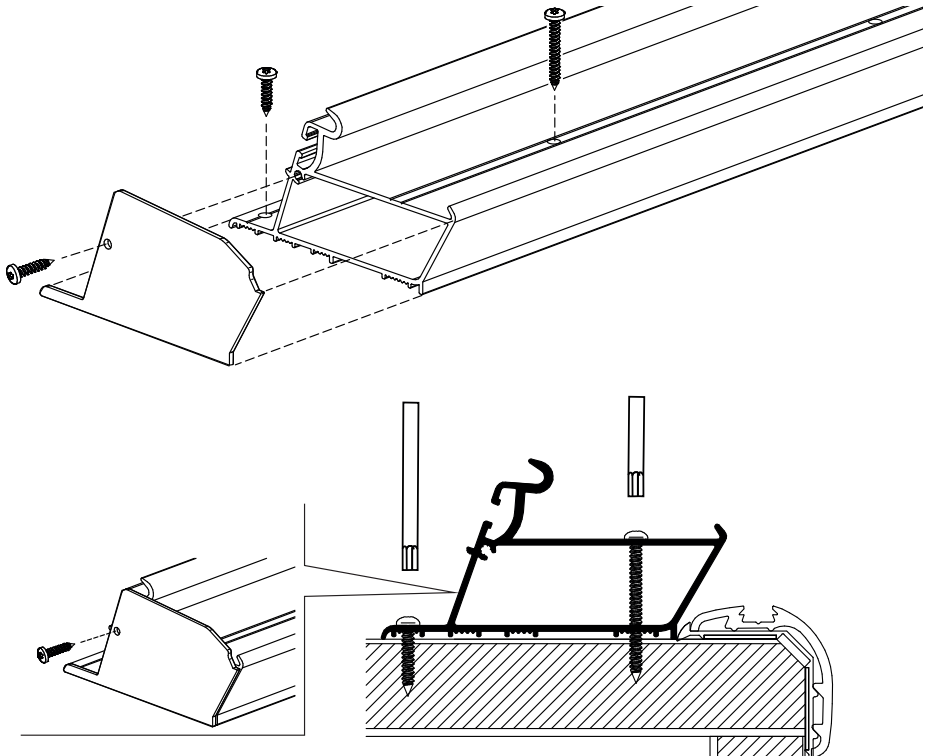

1

